

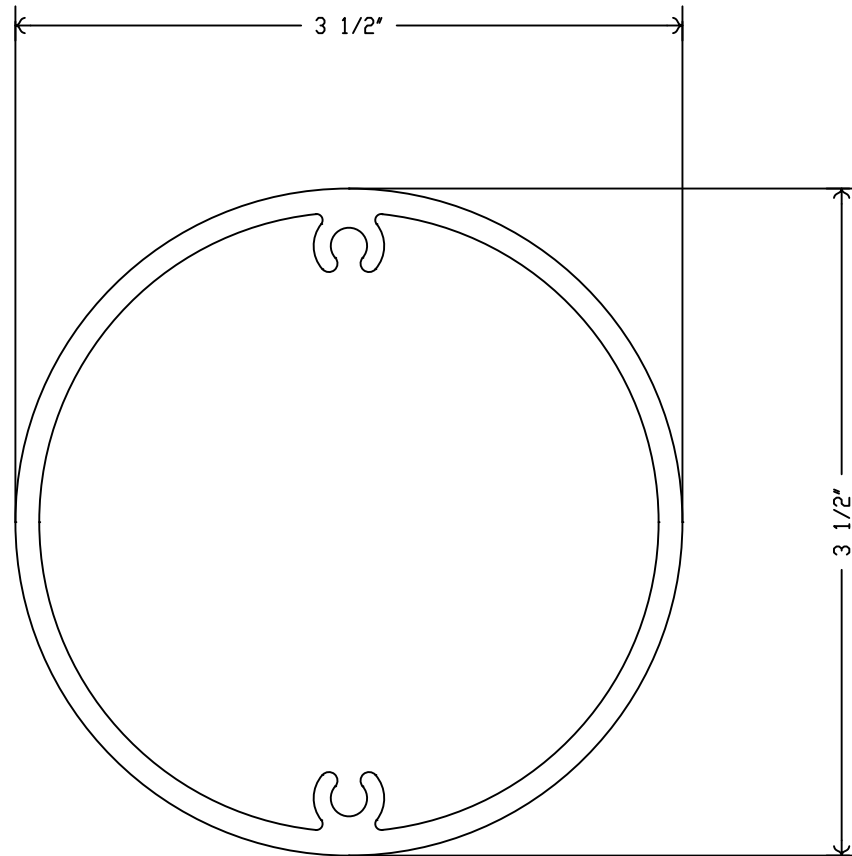

Industrial
Louvers, Inc.



Date: 7/7/2016

Part ID: TUBE1180

Description: 3 1/2 DIA X 1/8 TUBE MF

Scale: 1:1.0

Thickness: 0.125