

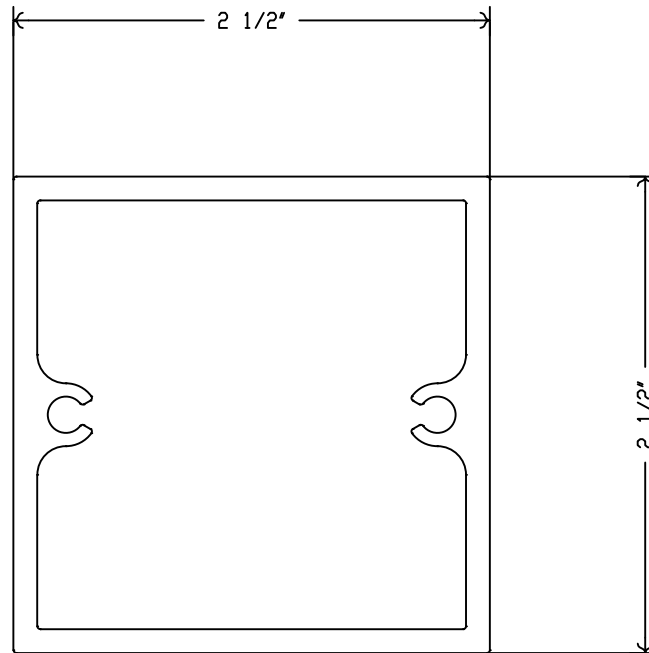

Industrial
Louvers, Inc.



Date: 7/7/2016

Part ID: TUBE1042

Description: 2.5 X 2.5 X 0.125 TUBE MF

Scale: 1:1.0

Thickness: 0.125