

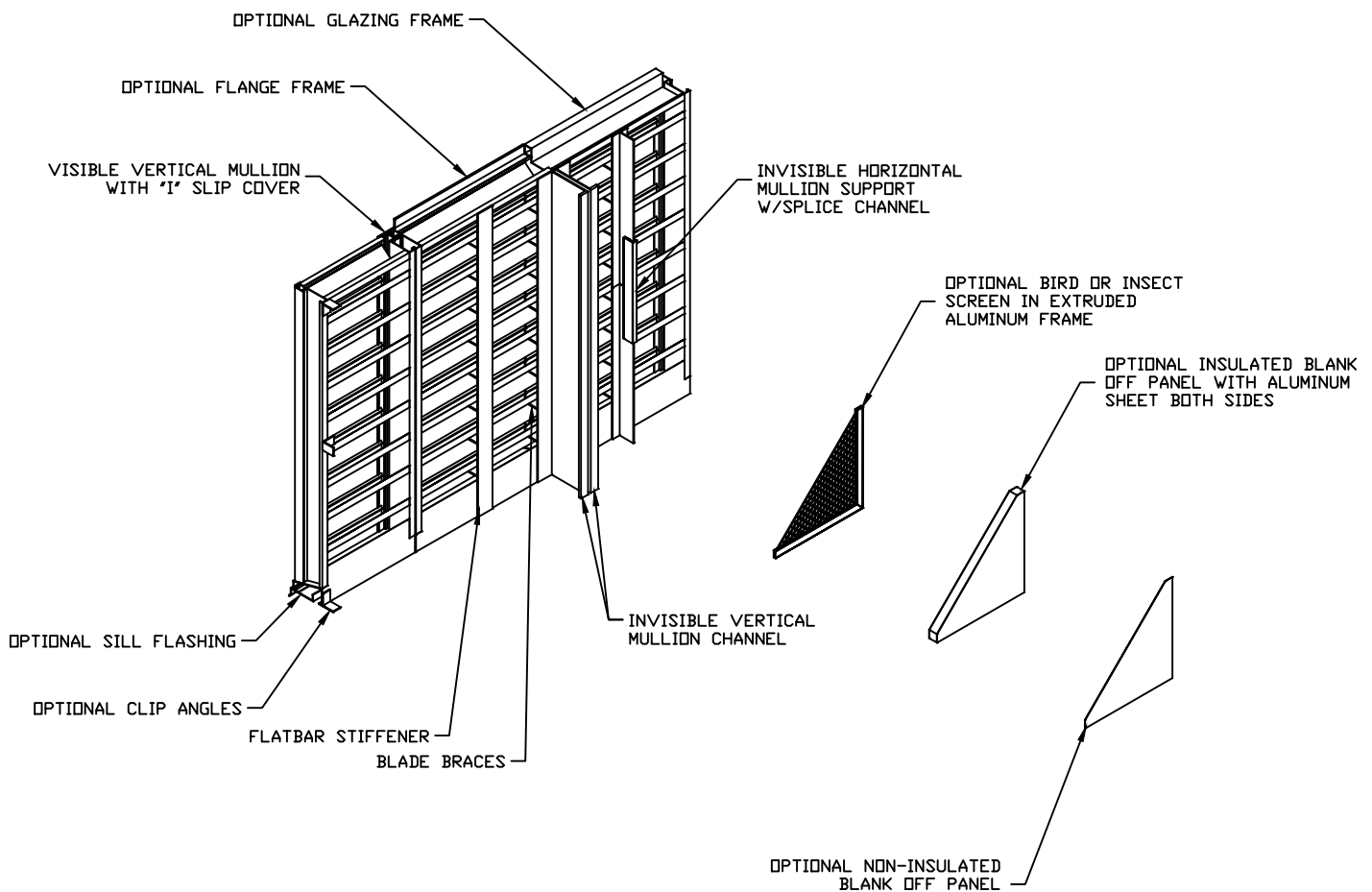

INSTALLATION INSTRUCTIONS FOR MODEL 456XP



- READ THESE INSTRUCTIONS COMPLETELY BEFORE STARTING INSTALLATION
- USE THESE INSTRUCTIONS IN CONJUNCTION WITH INDUSTRIAL LOUVERS SHOP DRAWINGS

STEP 1

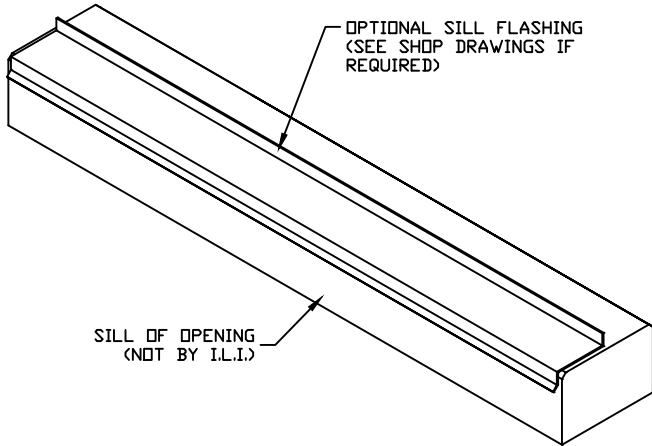

HEAD AND JAMBS ARE NOT SHOWN FOR CLARITY

INSTALLING SILL FLASHING

1. LOCATE IF SILL FLASHING IS REQUIRED PER SHOP DRAWINGS.
2. ATTACH APPLY CAULK (NOT BY I.L.I.) TO SILL OF OPENING SET SILL FLASHING IN CAULK.

STEP 2

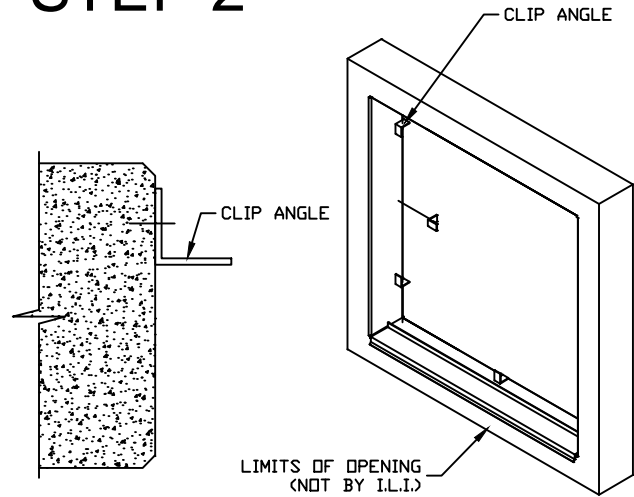

DETAIL

INSTALLING CLIP ANGLES

1. REFER TO SHOP DRAWINGS FOR SIZE AND DETAILS OF CLIP ANGLES.
2. MEASURE SET BACK PLACEMENT OF CLIP ANGLES, AND DRILL HOLES INTO WALL.
3. ATTACH CLIP ANGLES TO WALL. (ALL ANCHORS TO SURROUNDING CONDITIONS ARE NOT SUPPLIED BY I.L.I.)

STEP 3

INSTALLING LOUVER

1. PLACE LOUVER SECTION INTO OPENING.
2. SHIM AROUND LOUVER TO CREATE PROPER DISTANCE FROM SURROUNDING CONDITIONS. (SEE SHOP DRAWINGS FOR DETAILS)
3. ONCE PROPER PLACEMENT IS ACHIEVED. USE HOLES IN CLIP ANGLES TO DRILL PILOT HOLES IN JAMB, HEAD AND SILL.
4. FASTEN CLIP ANGLES TO LOUVERS WITH FASTENERS AS PROVIDED BY I.L.I.

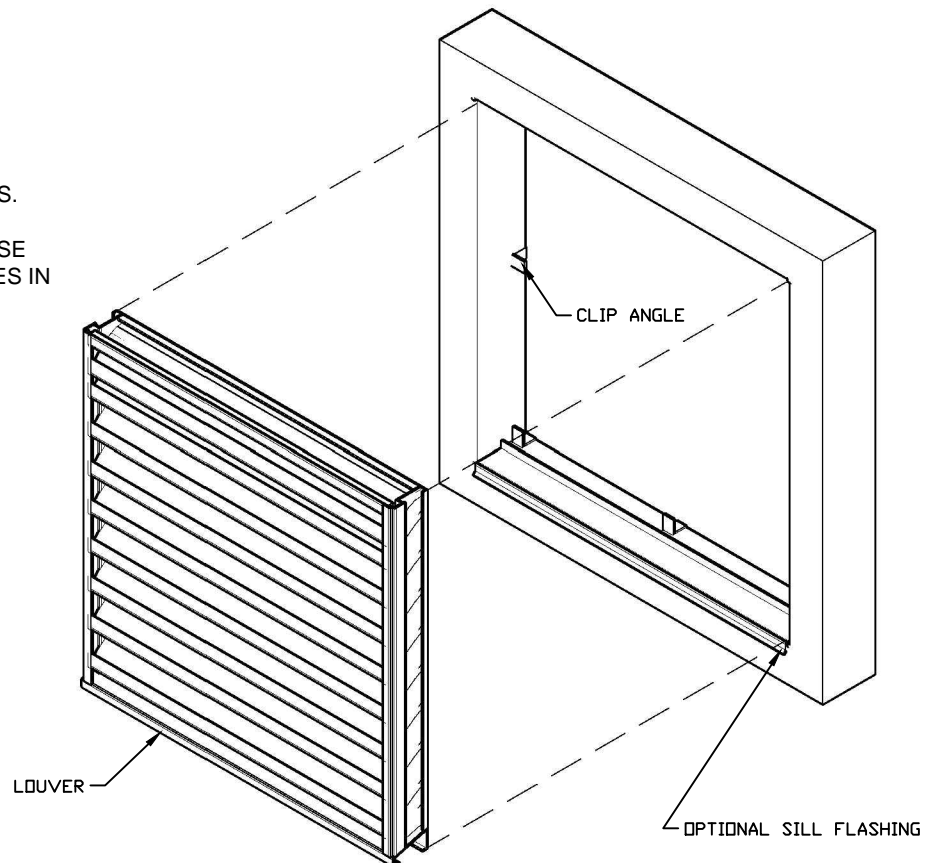

STEP 4

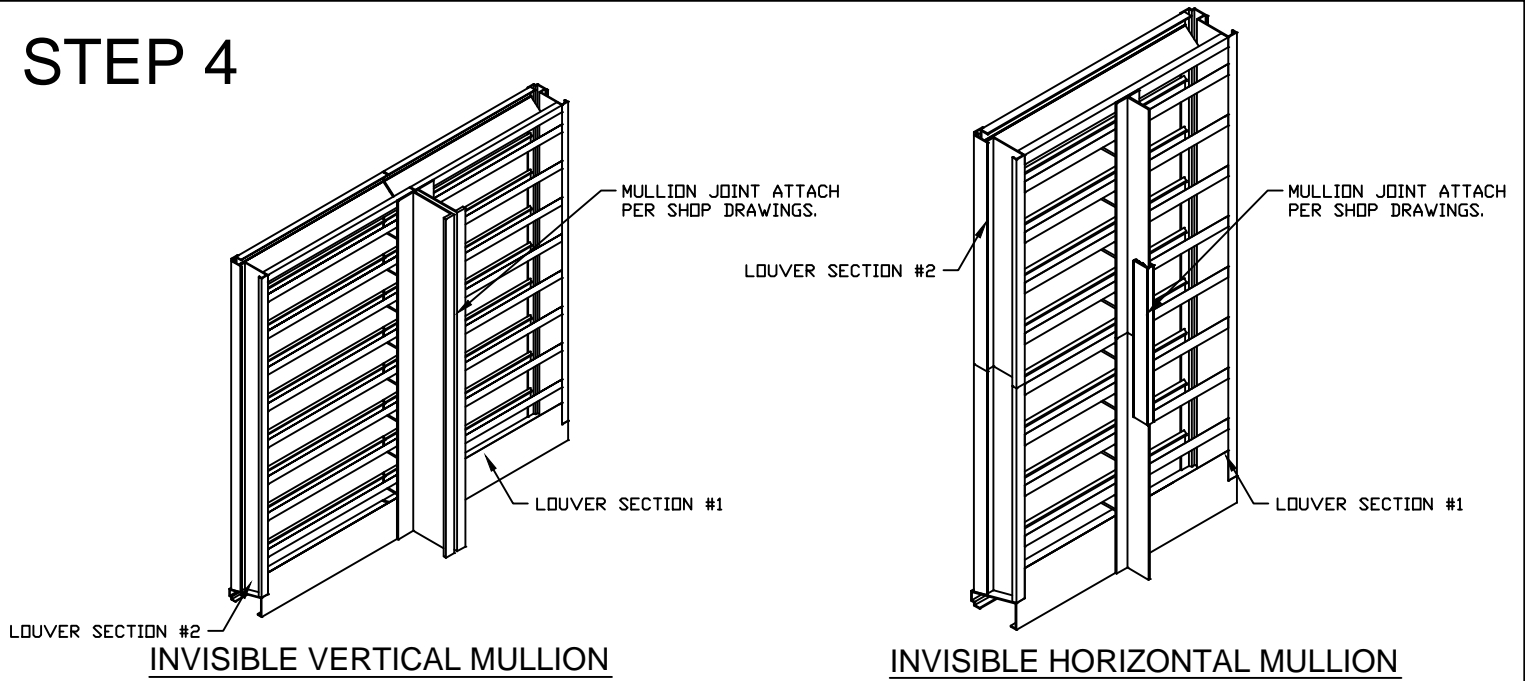

INSTALLING MULTI-SECTION LOUVERS

1. IF LOUVER IS SINGLE SECTION SKIP TO STEP 5.
2. IF LOUVER IS MULTI-SECTION INSTALL SECTION #1 AS PER STEP 1-3.
3. PUT SECTION #2 IN OPENING FOLLOWING STEPS 1-3. MAKING SURE SECTION # 1 ALIGNS WITH SECTION #2.
4. ATTACH MULLION JOINT PER SHOP DRAWINGS.
5. CONTINUE PROCESS UNTIL ALL SECTIONS ARE INSTALLED.

STEP 5

CAULKING

1. IF REQUIRED CAULK AROUND PERIMETER OF LOUVER AS SHOWN BELOW. (CAULK IS NOT SUPPLIED BY I.L.I.)

